

SECCIÓN A - A

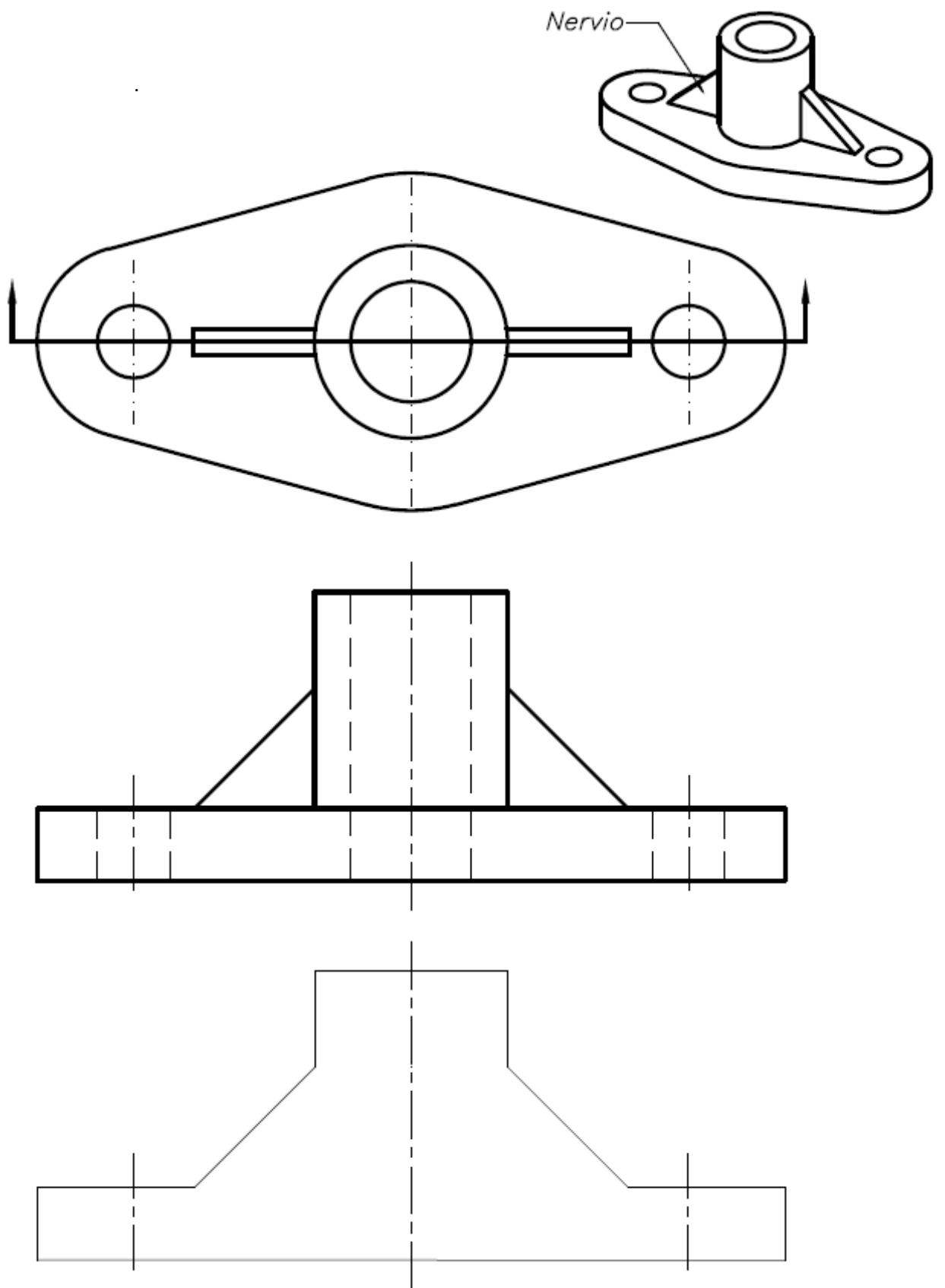

SECCION POR PLANOS PARALELOS

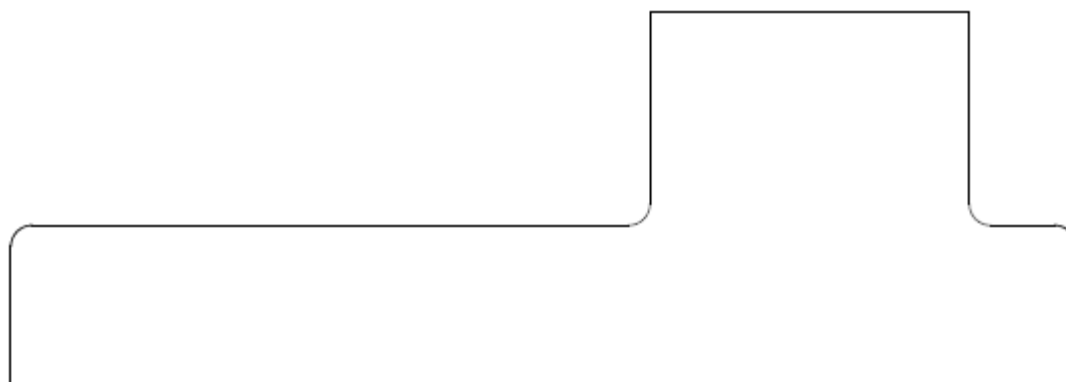
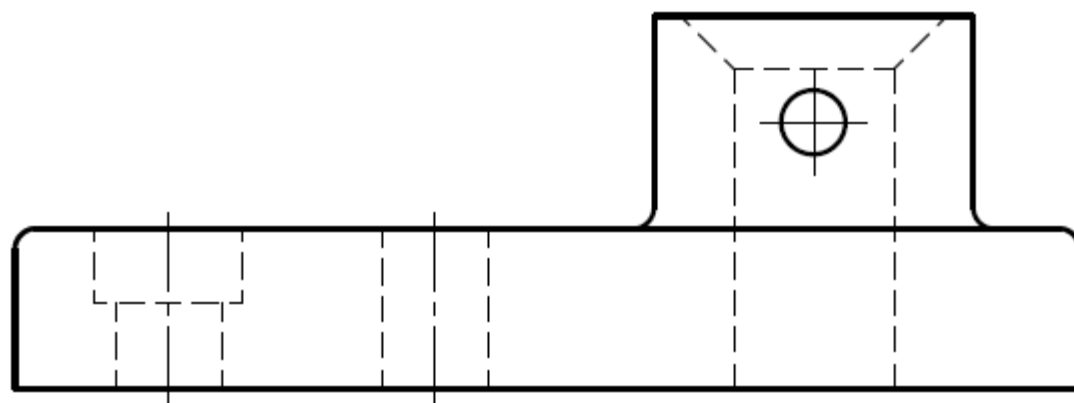
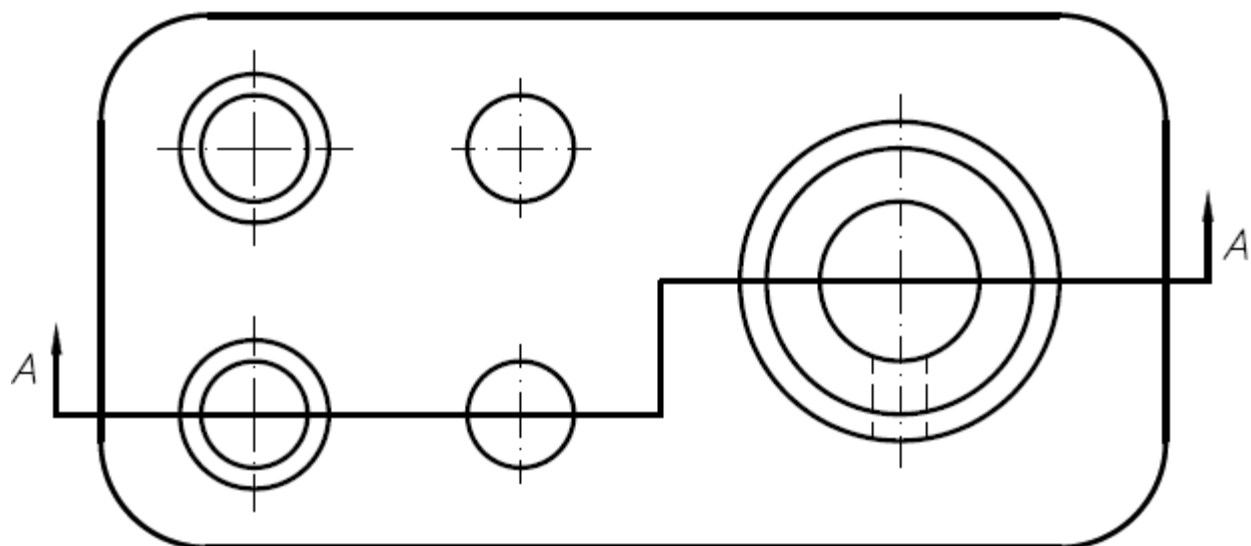

SECCIÓN A - A

SECCION ABATIDA

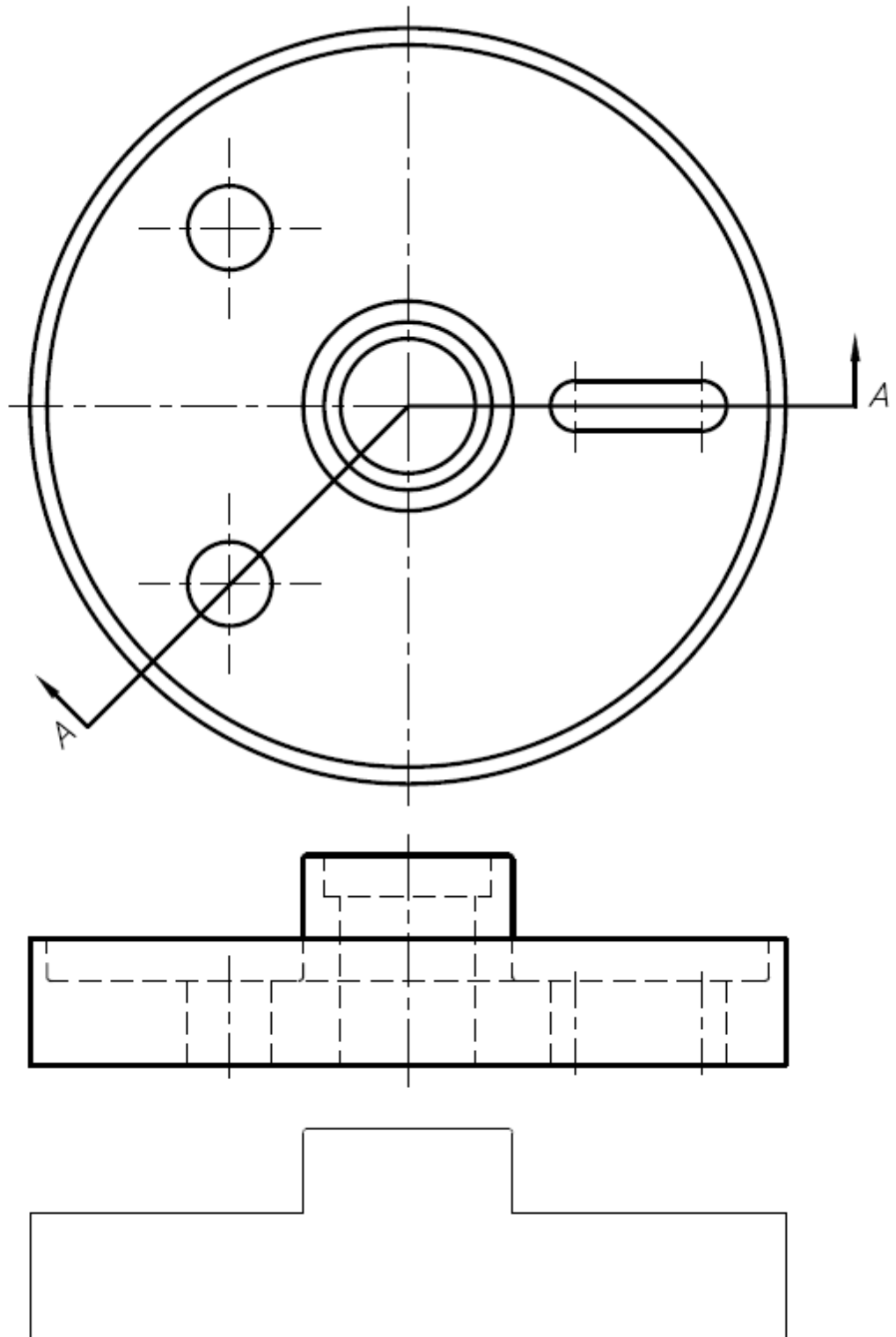

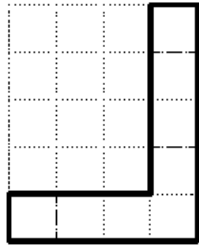
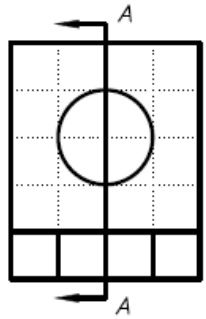
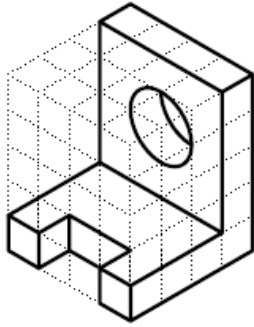
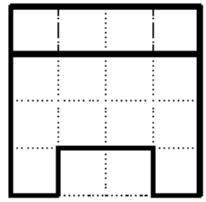

SECCIÓN A-A

SECCIÓN ABATIDA

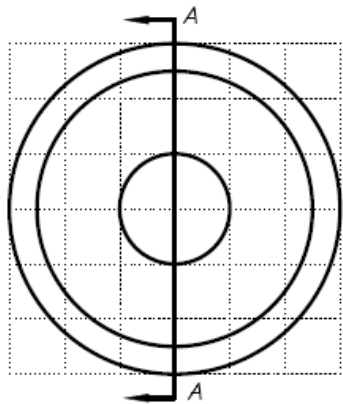
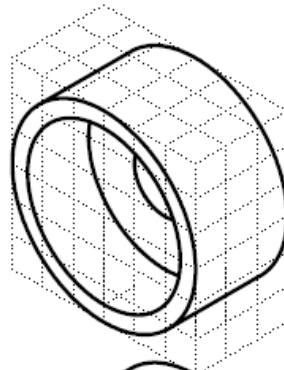
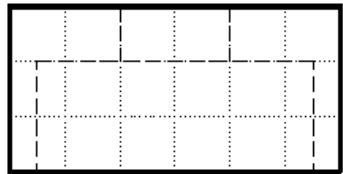
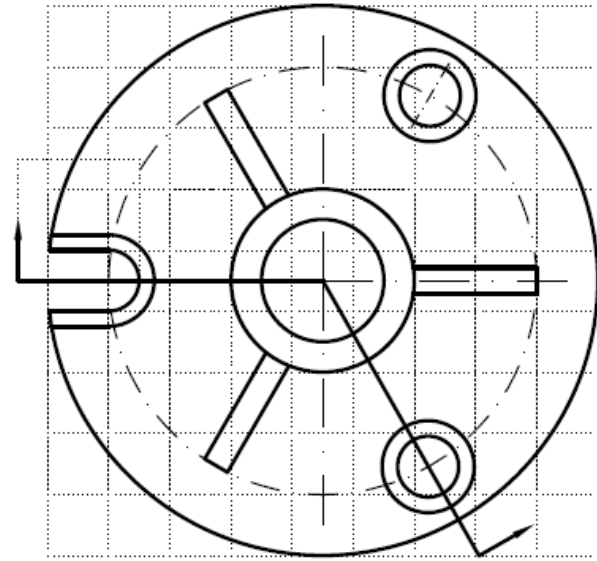

SECCIÓN A-A

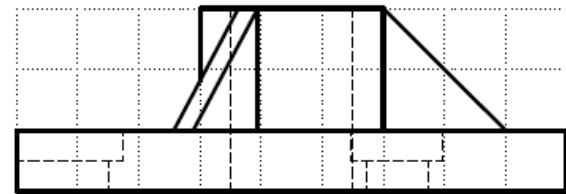
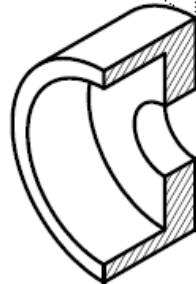

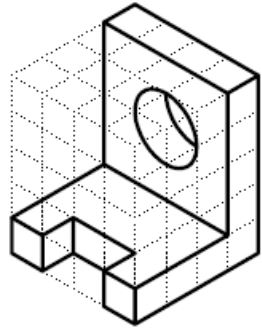
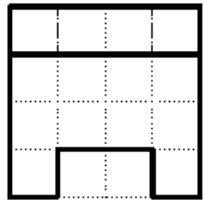

SECCIÓN B-B

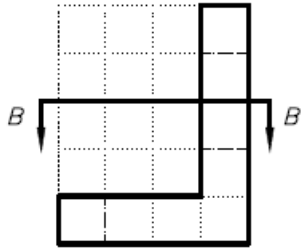
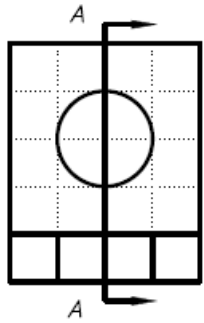

SECCIÓN A-A

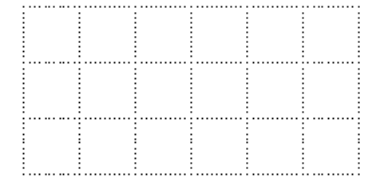
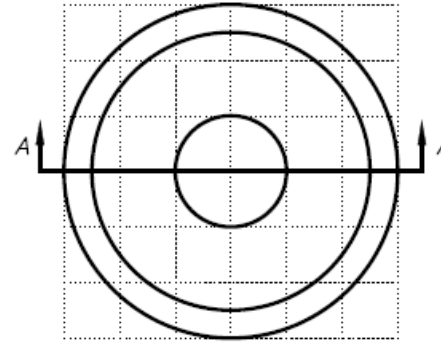
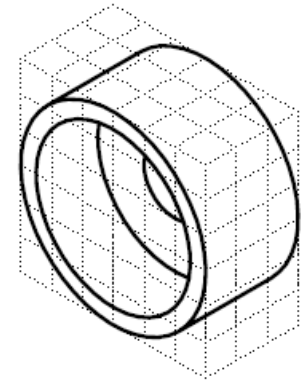

SECCIÓN A-A

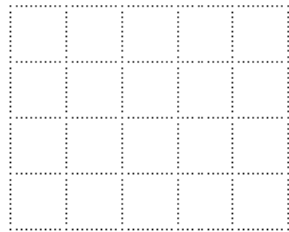
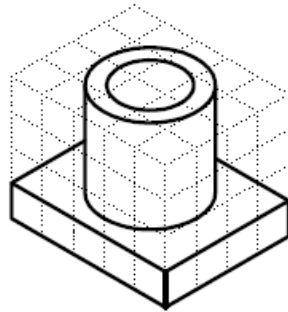
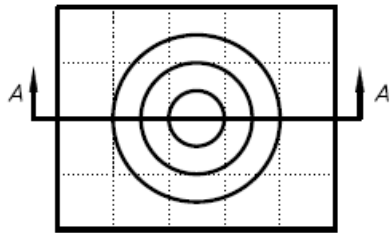

SECCIÓN A-A

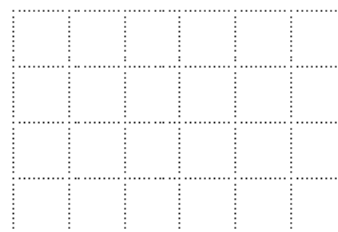
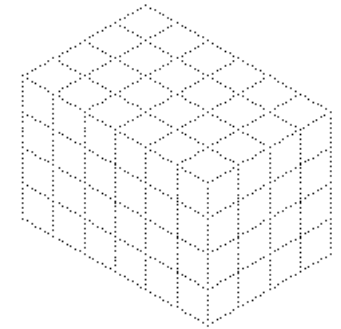
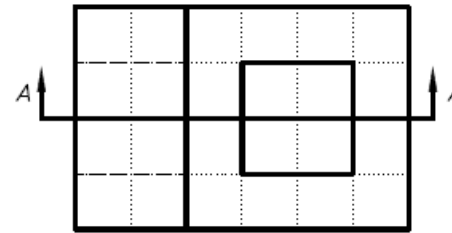
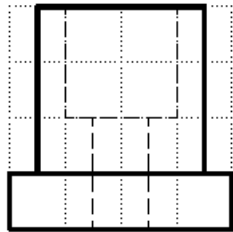

SECCIÓN A-A

